

POPOVER SUNDRESS

GIRL'S DRESS: SIZES 2, 3, 4, 5, 6, 7 + 8
DOLL'S DRESS FITS AN 18" DOLL



Girl's A-line sundress. Loose-fitting pull-on style with contrast yoke and bias ties at shoulder. Matching dress for an 18" doll.

SUGGESTED FABRICS: Light- to medium-weight woven fabrics like quilting cottons, batiste, lawn, broadcloth, chambray, seersucker, and linen. **NOTIONS:** Thread.

GARMENT MEASUREMENTS

SIZE	2	3	4	5	6	7	8
Dress length*	17 3/4"	18 1/4"	20 1/4"	22 1/4"	24 1/4"	26 1/4"	28 1/4"
Chest	22 1/2"	23 1/2"	24 1/2"	25 1/2"	26 1/2"	27 1/2"	28 1/2"

*from top of yoke to hem

FABRIC GUIDE (fabric width: 44" - 45")

SIZE	2	3	4	5	6	7	8
Dress Fabric*	1 yard	1 1/4 yard	1 1/4 yard	1 1/3 yard	1 1/3 yard	1 1/2 yard	1 1/2 yard
Trim Fabric*	3/4 yard	3/4 yard	3/4 yard	1 yard	1 yard	1 yard	1 yard

*the doll's dress can be made using leftover fabric from the girl's dress

NOTE: Due to space limitations, pattern piece #3, the bias straps, needs to be cut twice as long as the pattern piece itself. See the cutting layout for details.

GLOSSARY

Edgestitch: From the right side, straight-stitch 1/8" from and parallel to an edge, seam, or another stitching line, using your presser foot as a guide.

Finish the seam allowances: Run a zigzag stitch over the raw edge of the seam allowance, or straight-stitch 1/4" from the raw edge and trim the edge with pinking shears to prevent ravelling. A serger can also be used.

CUTTING LAYOUTS

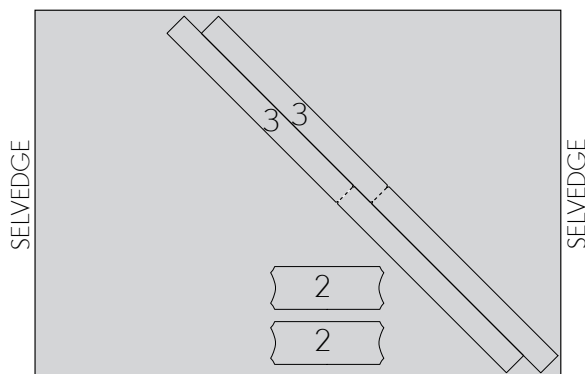

TRIM FABRIC: PIECES 2 AND 3 (NOTE THAT PIECE 3 SHOULD BE CUT TWICE AS LONG AS THE PATTERN PIECE ITSELF)

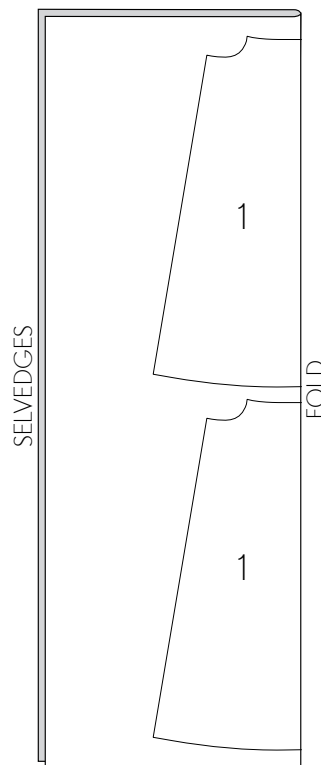

DRESS FABRIC 1: PIECE 1

SEWING INSTRUCTIONS

NOTE: These instructions refer to the girl's dress with 1/2" seam allowances. The construction of the doll dress is the same, but seam allowances are 1/4" instead.

ATTACH THE YOKE AND CONSTRUCT THE DRESS

1. Align and pin one yoke to the top of one dress panel, with the right side of the yoke facing the wrong side of the dress panel. (You'll notice that the top of the dress panel is curved, which will help the dress, when worn, flare at the front and back instead of just the sides.) Stitch the yoke to the dress panel with a 1/2" seam.

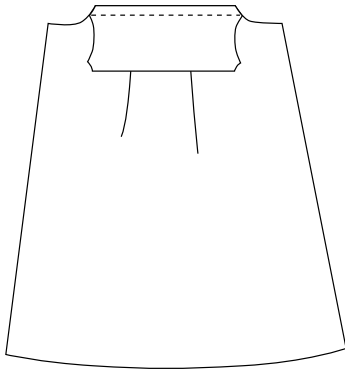

2. Press the seam flat to set the stitches; then press the seam allowances toward the yoke.

3. Fold and press the opposite edge of the yoke 1/2" to the wrong side.

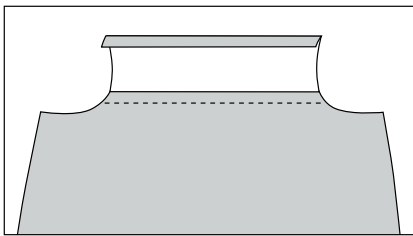

4. Fold the yoke over the seam allowances to the right side of the dress panel, and pin the yoke's folded edge so it covers the stitching from Step 1. Press the yoke flat. Working from the right side of the dress panel, edgestitch the yoke to the dress panel.

HINT: Slip a little rickrack or lace underneath the yoke edge before pinning and stitching. It's a great opportunity to add a little detail to the dress.

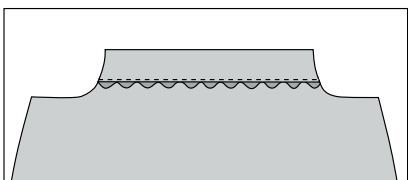

5. Follow steps 1 to 4 above to stitch the second yoke to the second dress panel.

6. With right sides together and the edges aligned, pin the two dress panels together at the side seams, and join each side with a 1/2" seam. Press the seam allowances open, and finish them as desired (see "Finish the seam allowances" in the Glossary).

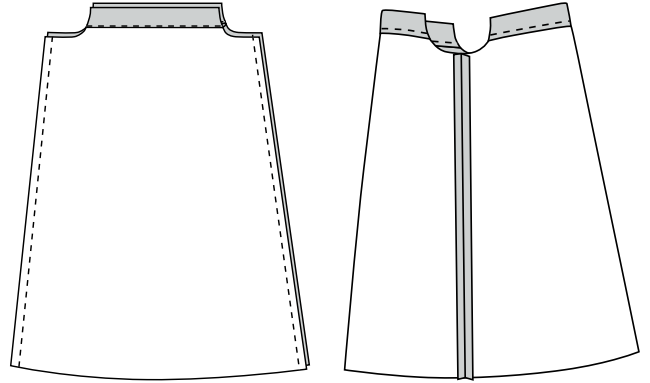

HINT: The side seams would also work well as french seams, if you prefer.

PREPARE AND ATTACH THE SUNDRESS STRAPS

1. Fold one strap in half lengthwise, with wrong sides together; and gently press the fold to create a center crease, being careful not to stretch the bias-cut strap as you press it.



2. Open the folded strap and lay it flat, wrong side up. Fold one of the strap's long raw edges in toward the center fold, and press a crease into this folded edge.

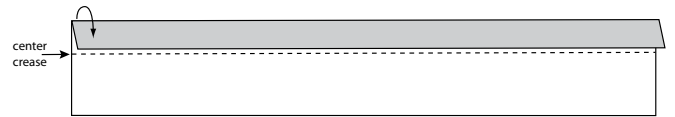

3. Turn the dress wrong side out. Find the center of the strap by folding it in half, matching the short ends. Then pin the strap to the dress's armhole, positioning the strap's center point at the side seam and working toward the yoke, pinning the raw unfolded edge of the strap to the raw edge of the armhole. The right side of the strap will face the wrong side of the dress. Join the strap and the armhole with a 1/2" seam. Take your time on the curve, taking care not to stretch the armhole as you stitch.

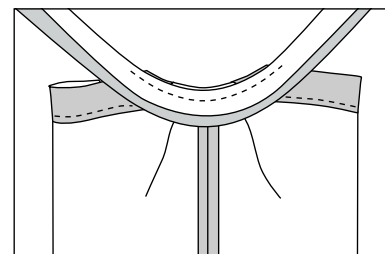

4. Press the strap toward the seam allowances of the armhole. Where the strap's length extends beyond the yoke of the dress, press the strap's unfolded edge toward the strap's center fold, as you did with the folded edge of the strap in Step 2 above.

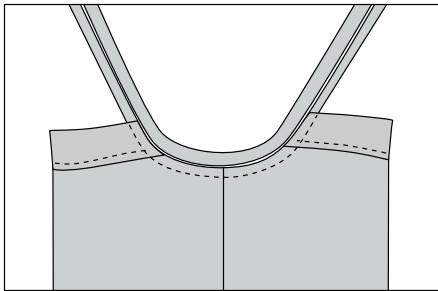

5. Fold and press the short ends of the straps toward the wrong side by approximately 1/2"; then re-fold the strap in half and pin it so that the raw edges are sandwiched in the center fold.

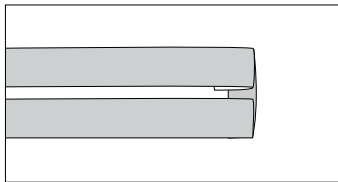

6. Re-fold the bias strip at the armhole so that it wraps over the seam allowances to the dress's right side, and pin the strap's folded edge from the right side so that it covers the seam line you sewed in Step 3.

7. Working from the dress's right side, edgestitch the strap starting at one end, sewing down the strap, around the armhole, and up the other end of the strap, rotating at the ends to stitch across and give them a clean finish.

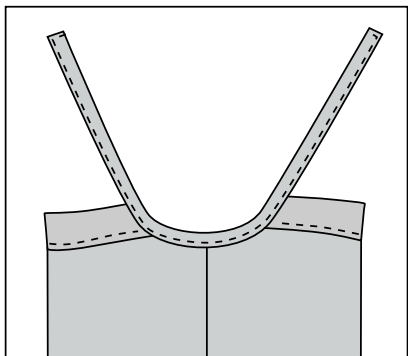

HEM THE DRESS

1. Sew a line of basting stitches $5/8$ " from the dress's raw bottom edge. This will become the fold line for the hem.
2. Fold and press the fabric's raw edge to the wrong side along the basting line.
3. Tuck the fabric's raw edge inside the fold to meet the line of basting stitches and create a narrow hem. Press, then edgestitch this fold to finish the hem.

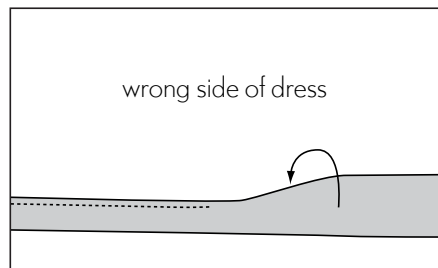

4. Remove the basting stitches from the fold line.

oliver + s discussion forums

For answers to sewing questions,
visit the discussion forums on our website:
www.oliverands.com/forums

oliver + s



New York, NY

This pattern is for private use only. The images, layout, design and other aspects of this pattern are copyright © Liesl + Co., Inc. 2011. If you wish to make and sell items from this pattern, please contact us for terms. Otherwise, no part of this design or pattern may be reproduced in any form.

www.oliverands.com

3 5 7 9 10 8 6 4 2

POPOVER SUNDRESS - FRONT AND BACK DRESS

1" TEST SQUARE

To ensure you have printed at the appropriate scale

DIRECTIONS:

Trim the edges from each piece of paper so just the grid is left. Join the pattern pieces together at the matching letters. For example, the side marked A on page 1 joins to the side marked A on page 2.

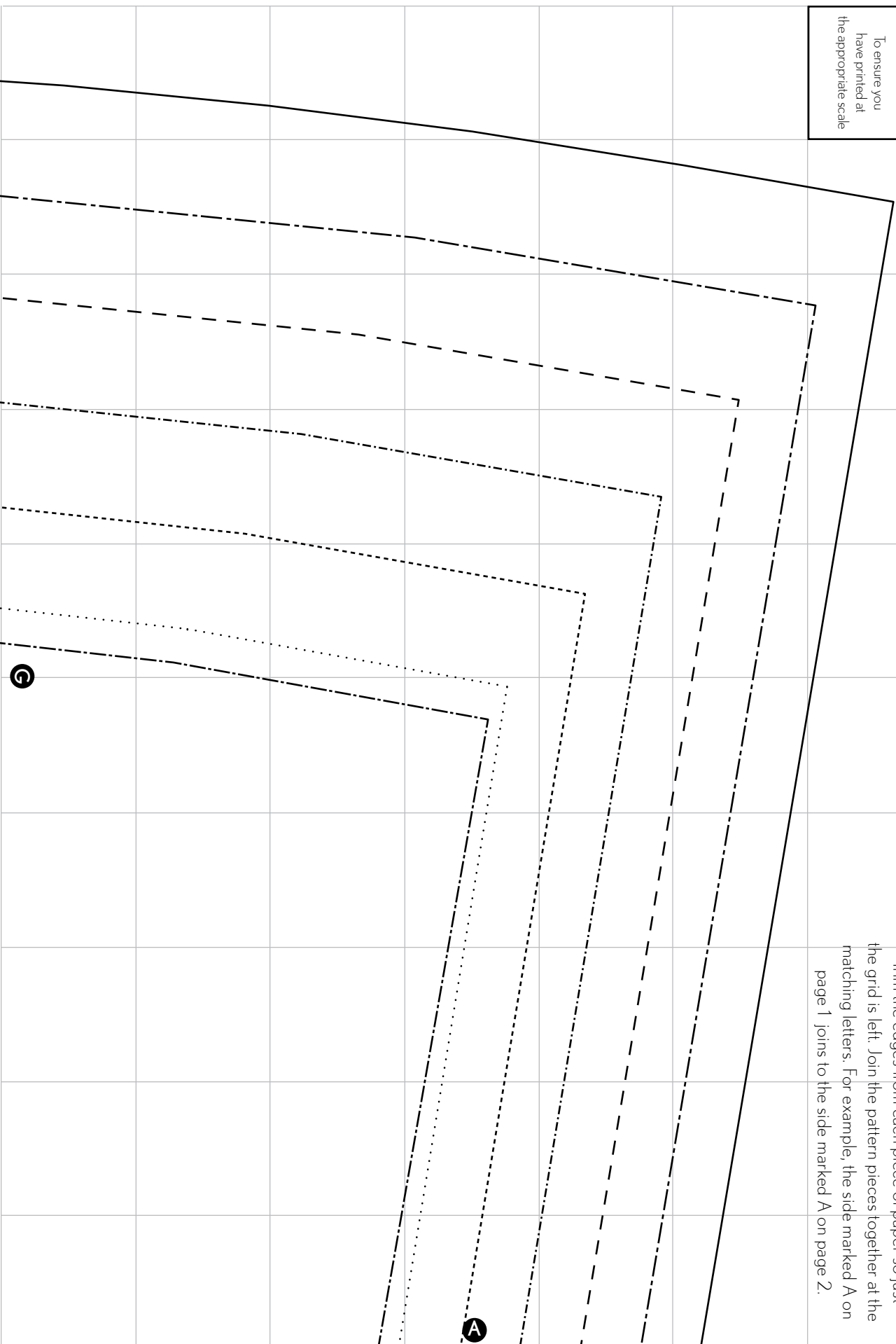

POPOVER SUNDRESS - FRONT AND BACK DRESS

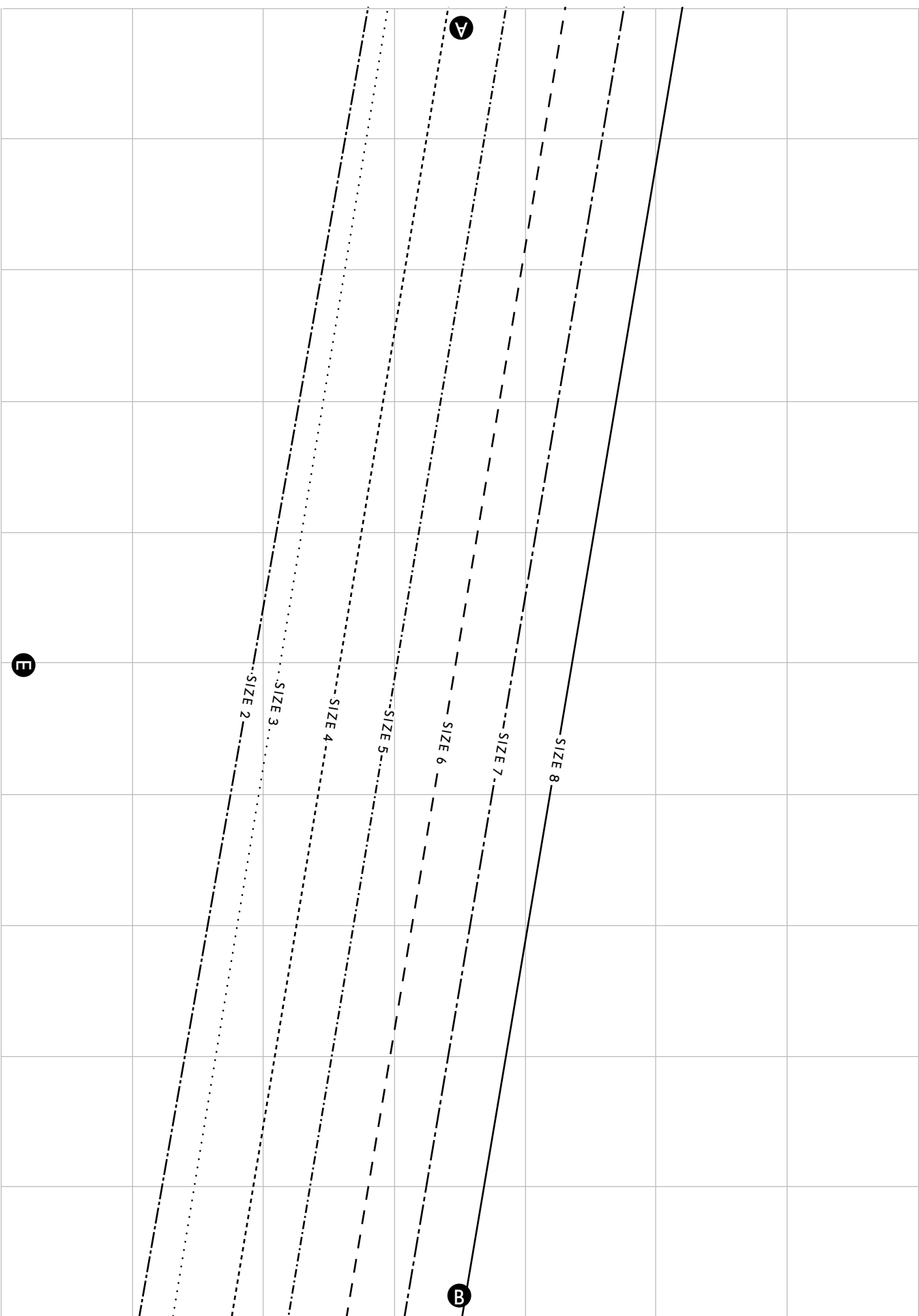

POPOVER SUNDRESS - FRONT AND BACK DRESS

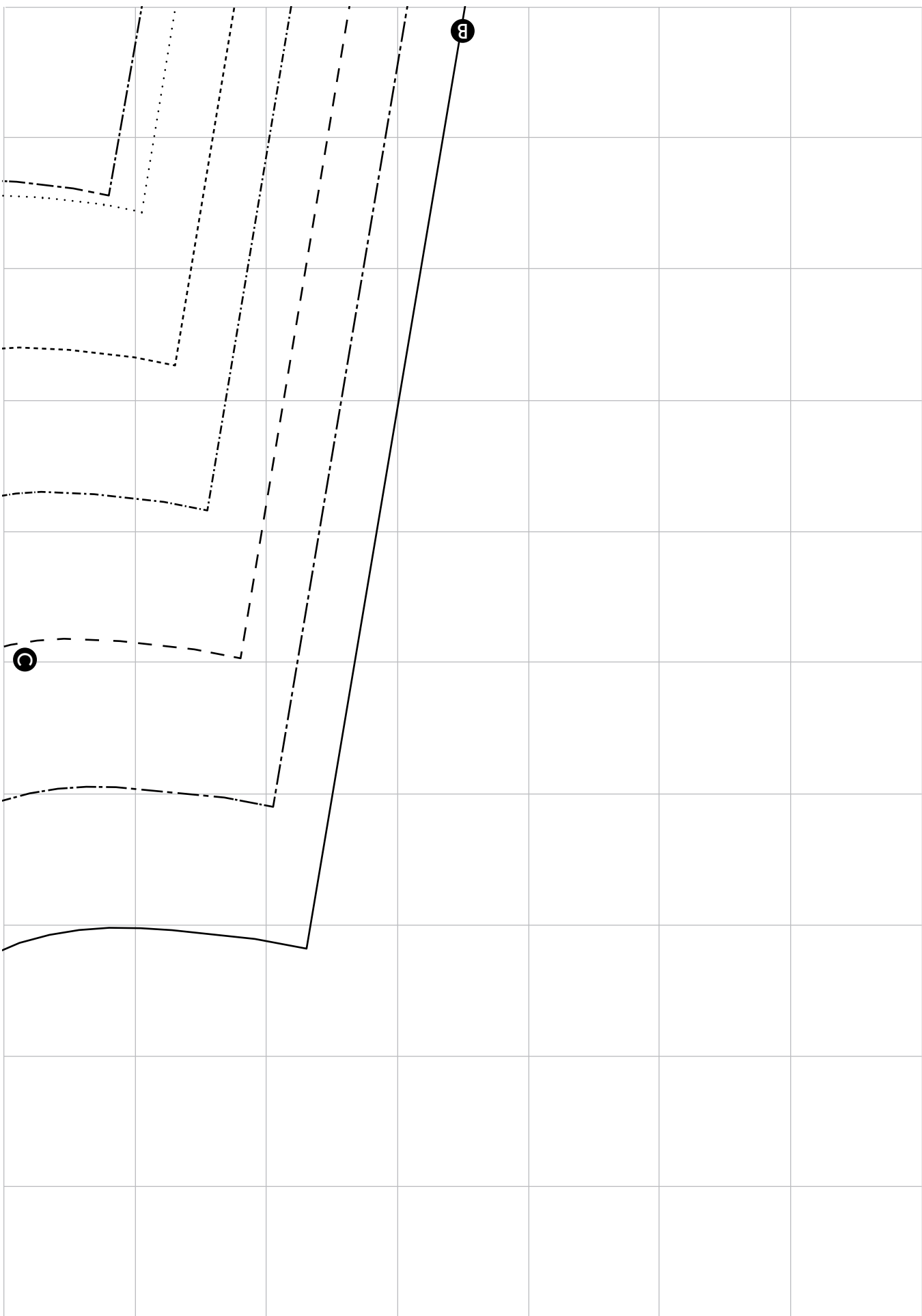

POPOVER SUNDRESS - FRONT AND BACK DRESS

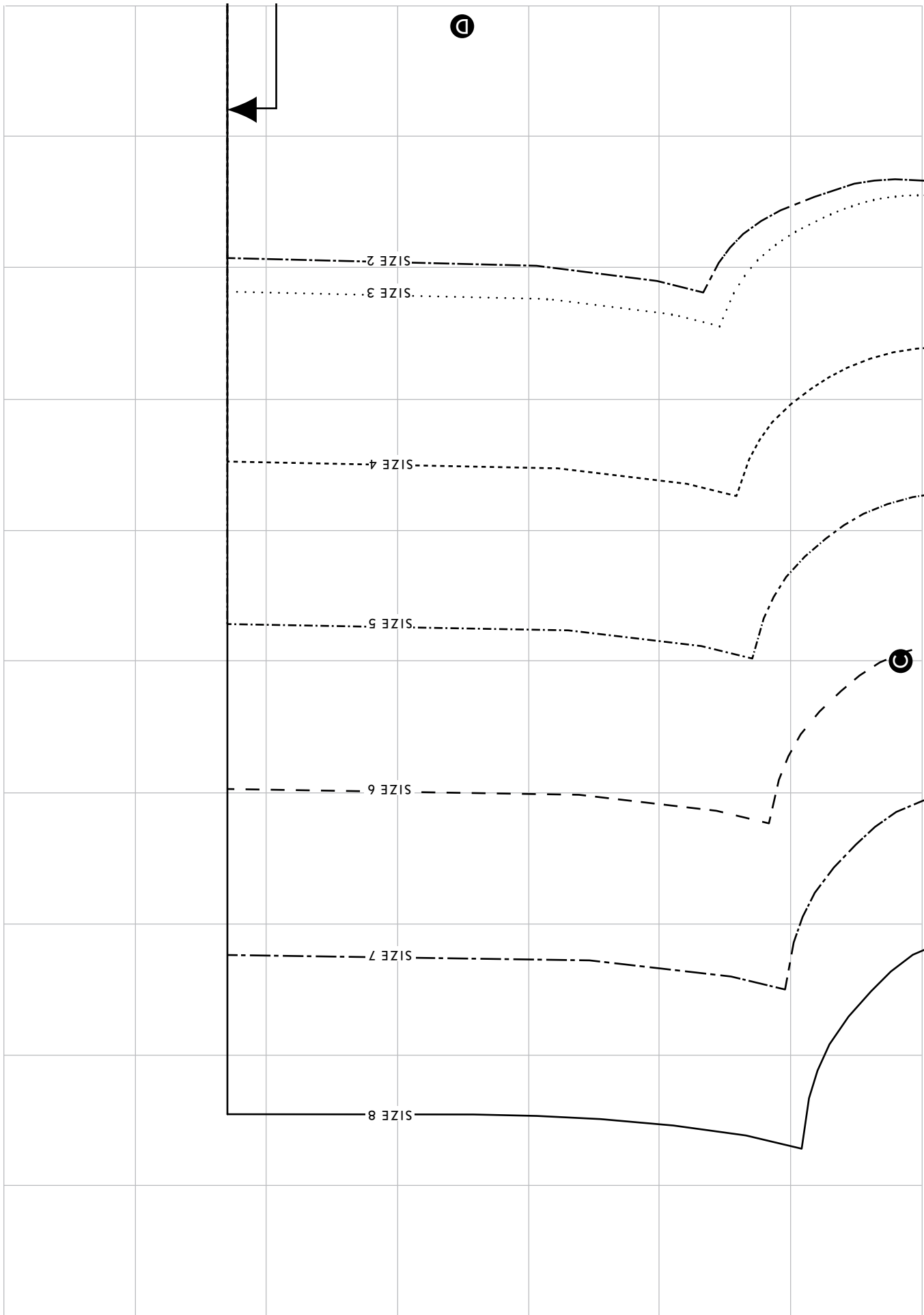

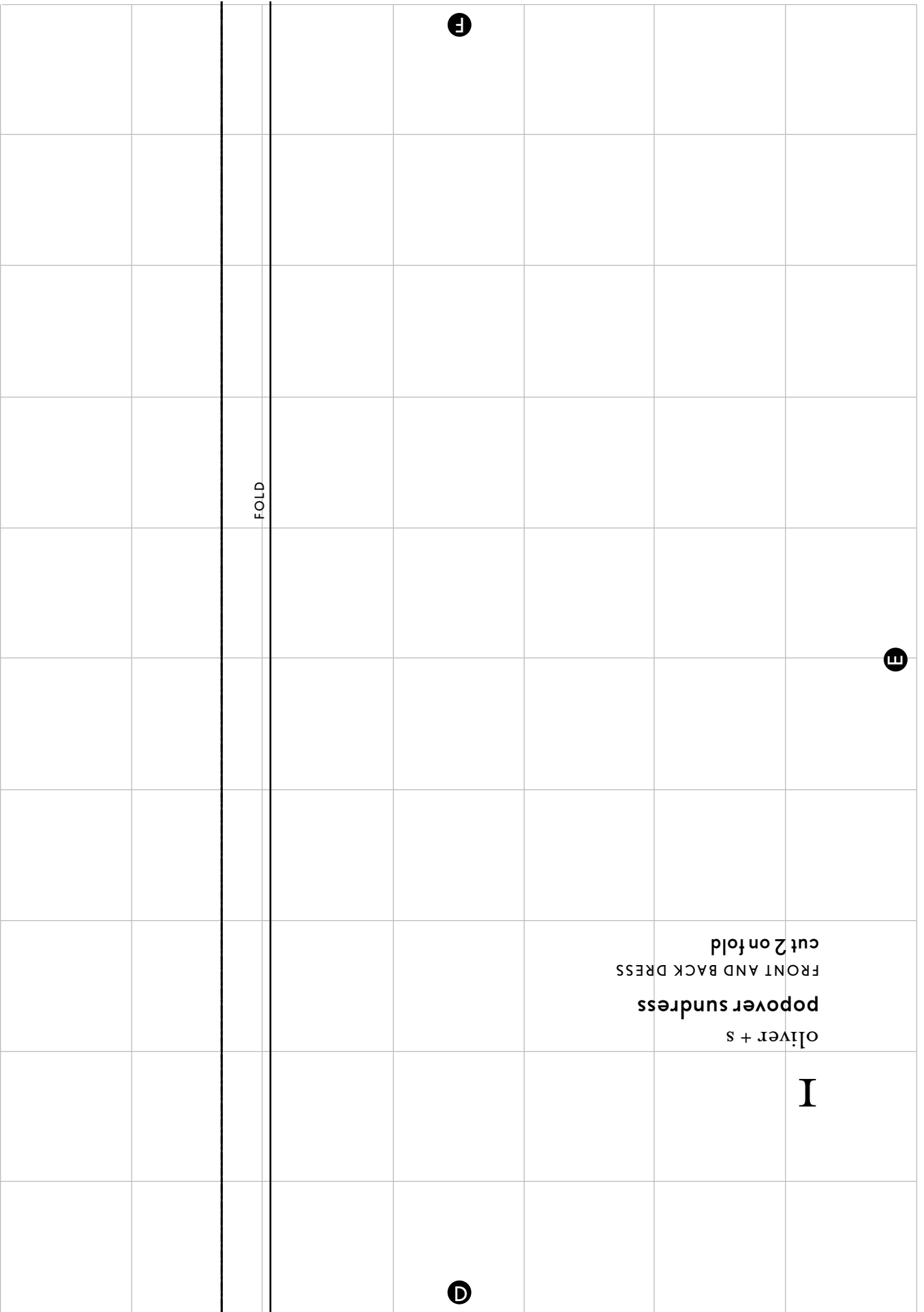

POPOVER SUNDRESS - FRONT AND BACK DRESS

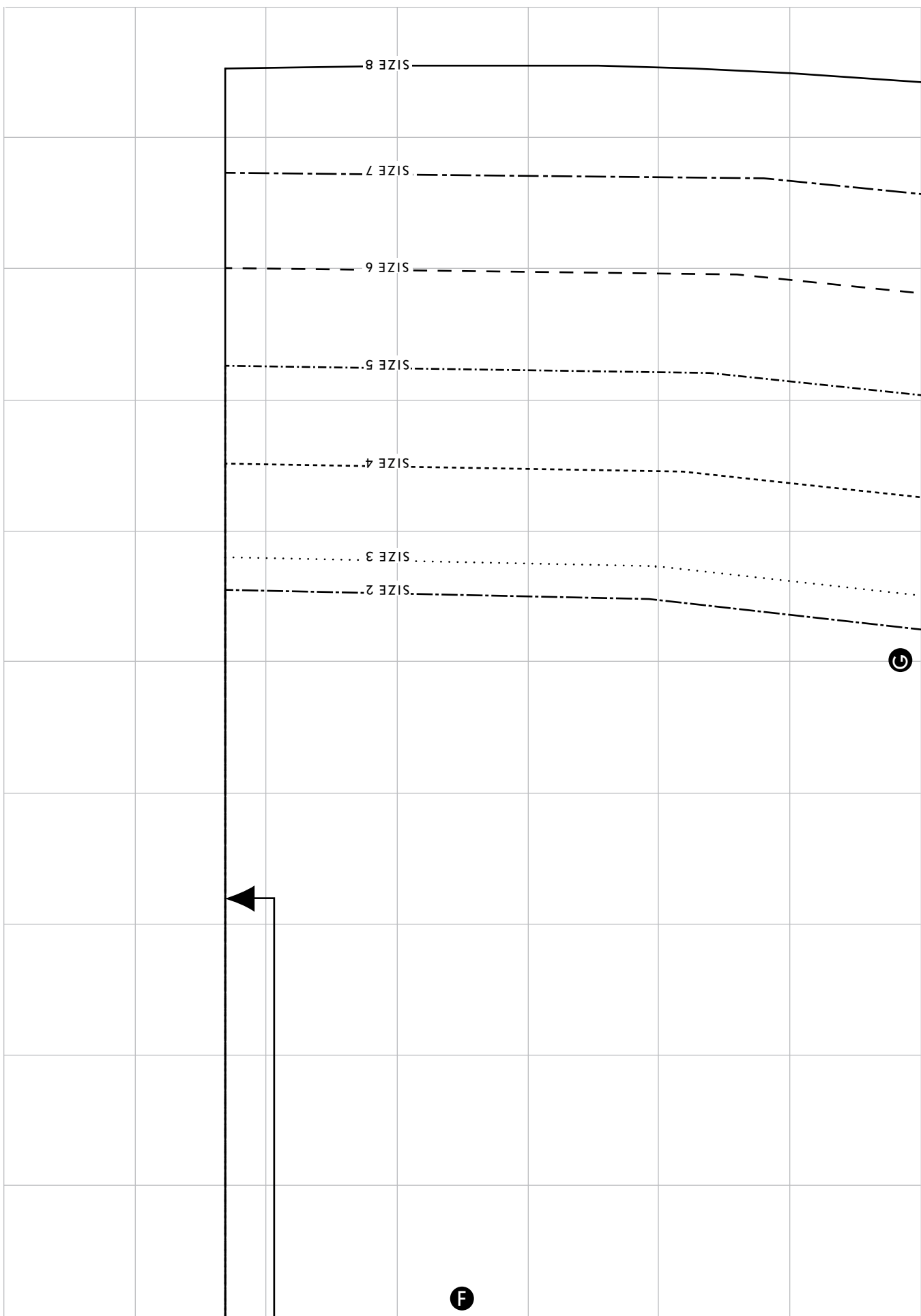

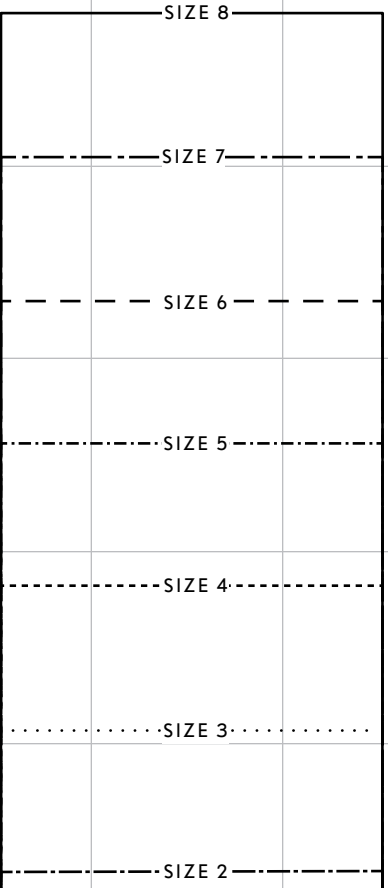
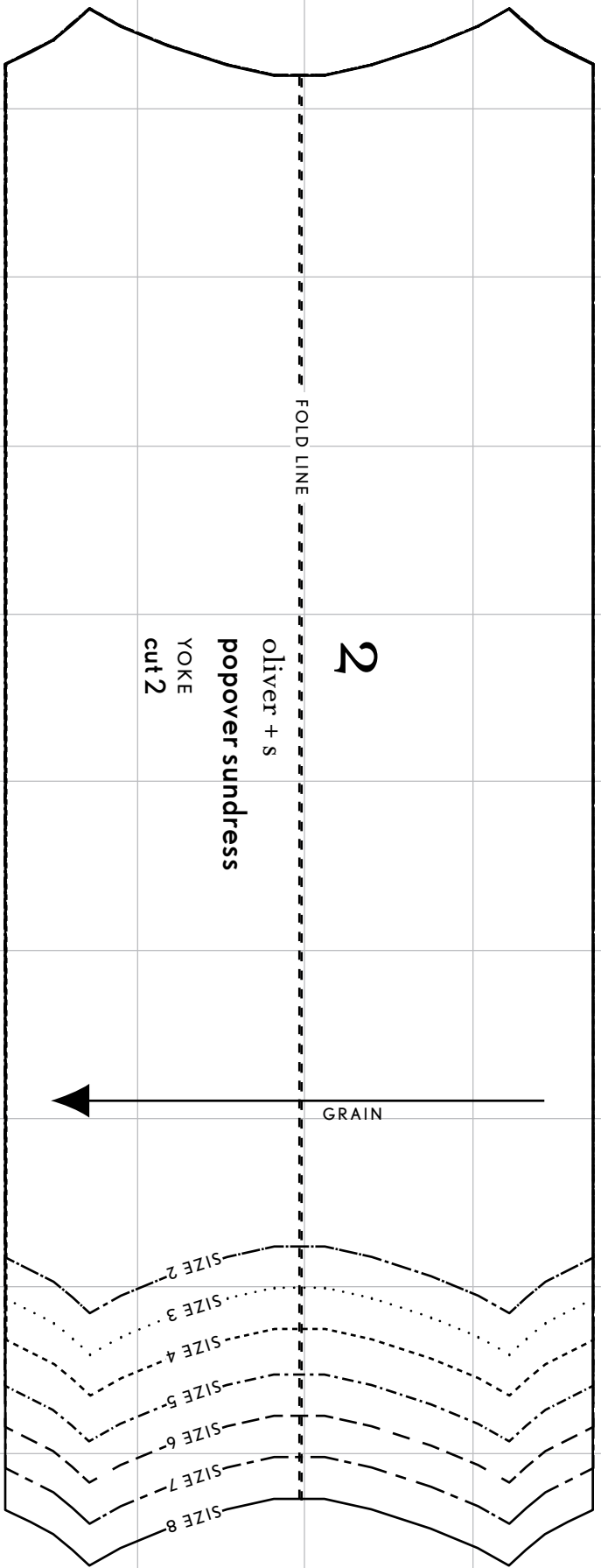

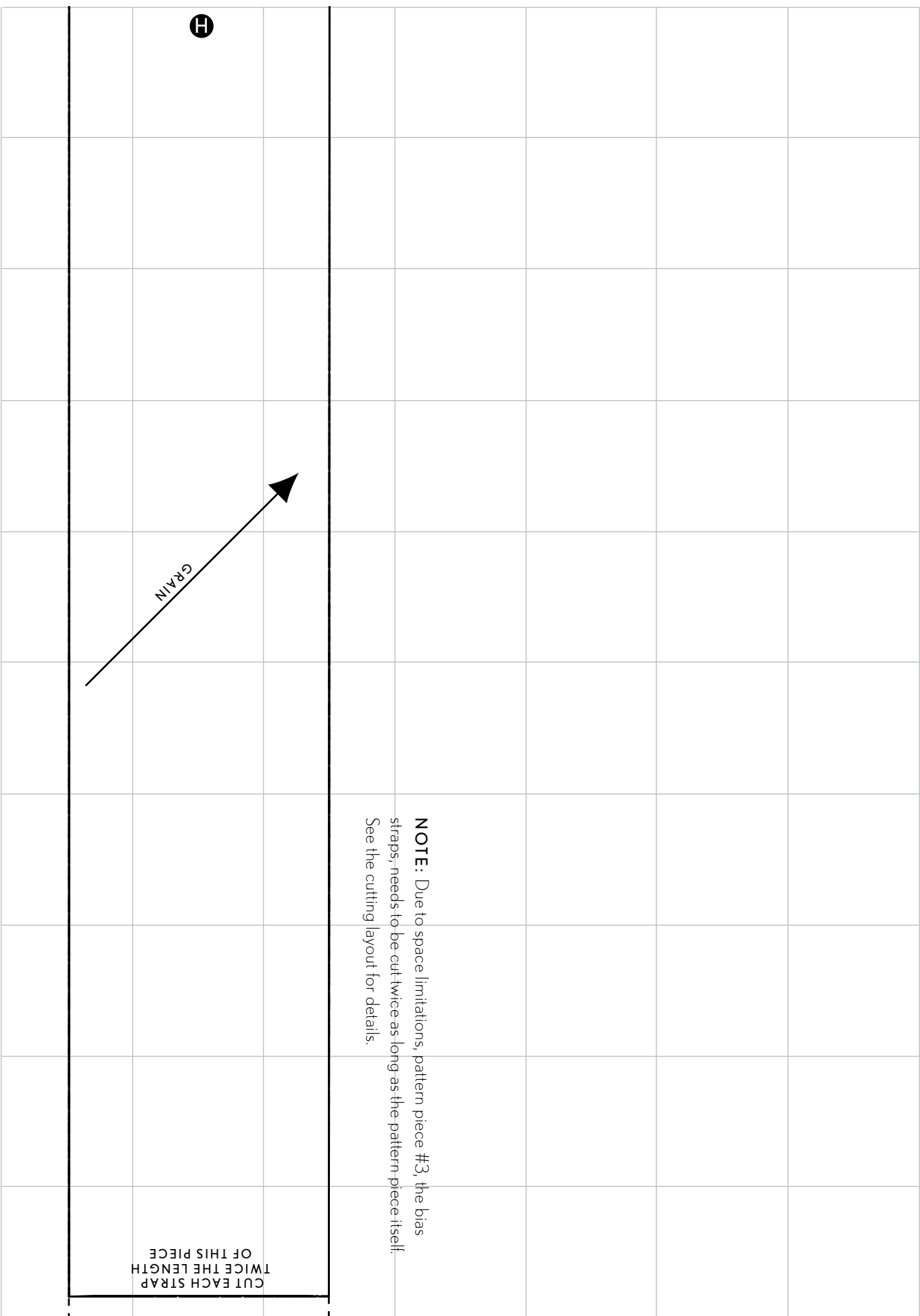

NOTE: Due to space limitations, pattern piece #3, the bias straps, needs to be cut twice as long as the pattern piece itself. See the cutting layout for details.

CUT EACH STRAP
TWICE THE LENGTH
OF THIS PIECE

oliver + s

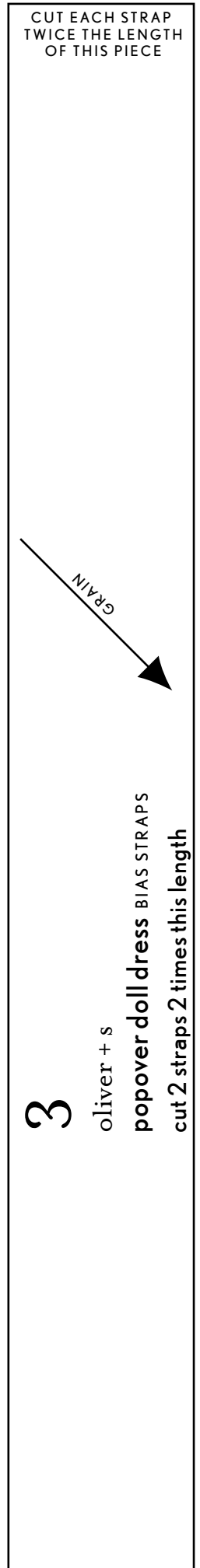
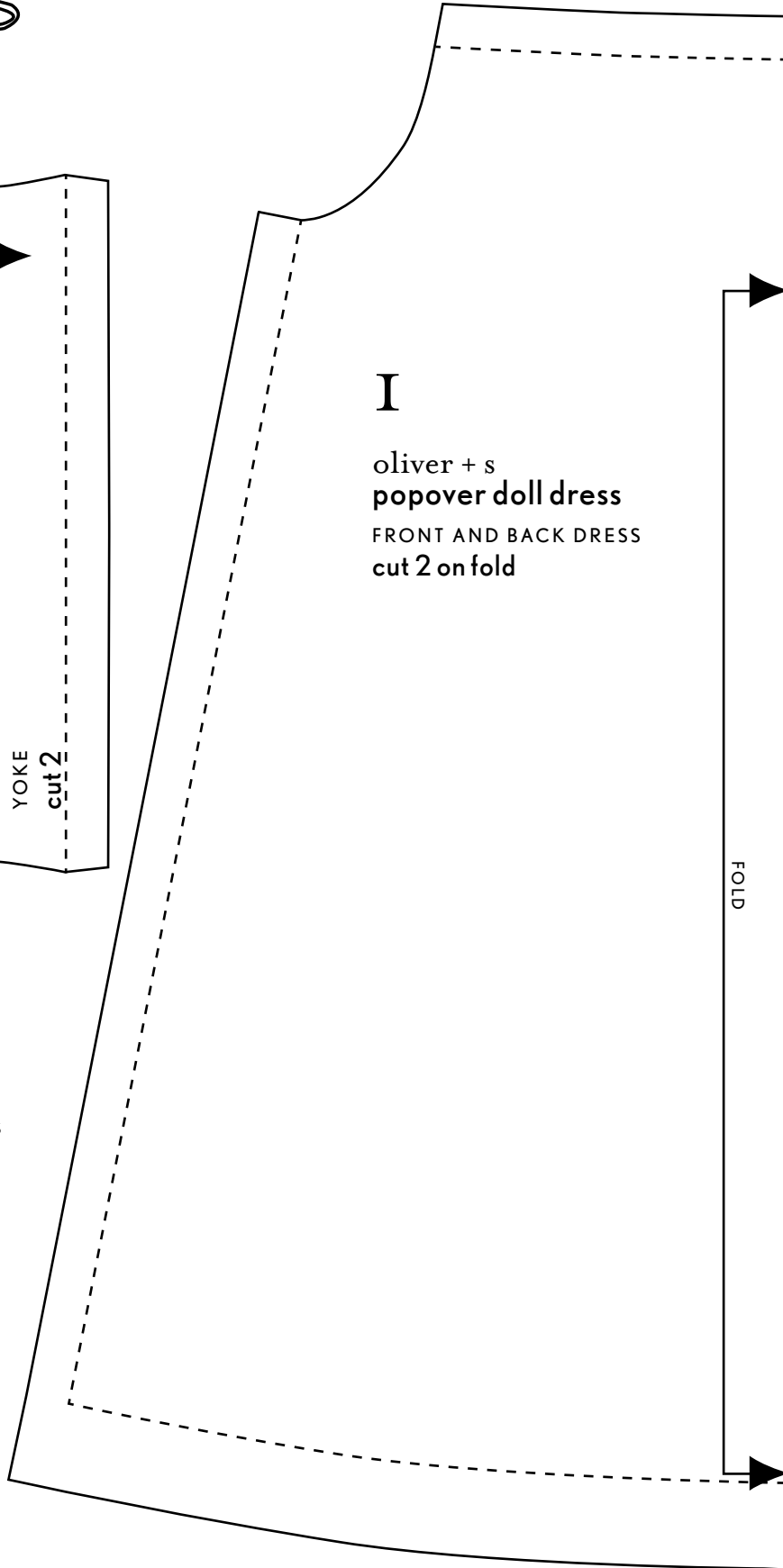
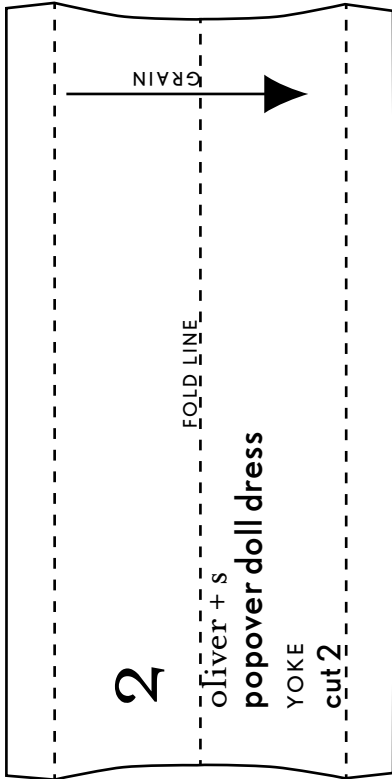
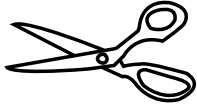

1/4" seam allowances unless otherwise indicated